



# Control Panel

ICP-SOL2-P/ICP-SOL3-P



**BOSCH**

**en** Quick Reference Guide



## Table of contents

<b>1</b>	<b>Introduction</b>	<b>6</b>
<b>2</b>	<b>Programming</b>	<b>7</b>
2.1	ICON LCD Codepad Programming	7
2.2	TEXT LCD Codepad Menu Programming	8
2.3	Programming Option Bits	9
2.4	Installer's programming commands	9
<b>3</b>	<b>Operating Commands</b>	<b>10</b>
3.1	Add/Delete RF Device (Wireless Zones)	12
3.2	Add/Delete RF Repeater	12
3.3	Add/Delete RF Keyfob	12
3.4	Set First Test Report	13
3.5	Change Domestic Telephone Numbers	13
3.6	Change the Telco Arm/Disarm Sequence	13
3.7	Set STAY Mode 2 Zones	14
3.8	Report Monitor Mode (Toggle On/Off)	14
3.9	Walk Test Mode	14
3.10	Event Memory Recall	14
<b>4</b>	<b>Programming Parameters</b>	<b>15</b>
4.1	Phone Programming	15
4.1.1	Receiver 1	15
4.1.2	Receiver 2	15
4.1.3	Dialing Format	16
4.1.4	External Network Module 1	16
4.1.5	External Network Module 2	16
4.1.6	Password for A-Link Plus/RSC Connection	16
4.1.7	Telco Arming Sequence (Call Forward On)	16
4.1.8	Telco Disarm Sequence (Call Forward Off)	16
4.1.9	Call Back Telephone Number	16
4.1.10	Ring Count	17
4.1.11	Telephone Line Fail Options	17
4.1.12	Dialer Options 1	17
4.1.13	Dialer Options 2	17
4.1.14	Dialer Options 3	18
4.1.15	A-Link Plus Options	18
4.2	Installer Code	18
4.3	User Code Programming	18
4.4	Day Alarm Zones	20
4.5	EOL Resistor Value	20
4.6	Zone Programming	20
4.7	Swinger Programming	23
4.7.1	Swinger Shutdown Count For Siren	23
4.7.2	Swinger Shutdown Count For Dialer	24
4.8	Zone Status Programming	24
4.8.1	STAY Mode 2 Automatically Bypass Zones	24
4.8.2	Reserved	24
4.8.3	Zone Status Reporting Options	24
4.9	RF Programming	25

4.9.1	RF Supervision Time	25
4.9.2	RADION Anti-Jamming Sensitivity	25
4.9.3	RF Receiver	25
4.9.4	RF Options	25
4.9.5	Reserved	25
4.10	Report Programming	25
4.10.1	Reserved	25
4.10.2	Arm / Disarm Reporting Options	26
4.10.3	Reserved	26
4.10.4	Codepad Reporting Options	26
4.11	System Status Programming	26
4.11.1	Reserved	26
4.11.2	Access Denied(Code Retry)	26
4.11.3	System Status Reporting Options	26
4.12	Test Report Programming	27
4.12.1	Test Report Time (Automatic)	27
4.12.2	Test Reporting Dialer Options	27
4.13	Output Programming	27
4.14	Time Programming	31
4.14.1	Entry Time 1	31
4.14.2	Entry Time 2	31
4.14.3	Exit Time (AWAY/STAY Modes)	31
4.14.4	Entry Guard Time For STAY Mode	31
4.14.5	Delay Alarm Report Time	31
4.14.6	Sensor Watch Time	31
4.14.7	Codepad Lockout Time	31
4.14.8	Siren Run Time	32
4.14.9	Siren Sound Rate	32
4.14.10	Auto Arming Pre-Alert Time	32
4.14.11	Auto Arming Time	32
4.14.12	Auto Disarming Time	32
4.14.13	Kiss-Off Wait Time	32
4.14.14	Speaker Beep Volume	33
4.15	Options Programming	33
4.15.1	System Options 1	33
4.15.2	System Options 2	33
4.15.3	System Options 3	33
4.15.4	System Options 4	33
4.15.5	Consumer Options 1	34
4.15.6	Consumer Options 2	34
4.15.7	Consumer Options 3	34
4.15.8	Reserved	34
4.15.9	Partitioning Options 1	34
4.15.10	Partitioning Options 2	35
4.16	Partition Allocations	35
4.16.1	Zone Area Assignment	35
4.16.2	Codepad Assignment	35
4.16.3	Reserved	35
4.16.4	User Code Area Assignment	36
4.17	Default Options	36

---

4.18	IP Destination	36
4.19	RF User Code ID Numbers	38
4.20	RF Zone/Device ID Numbers and RF Zone Option	38
4.21	RF Repeater ID Numbers	39
4.22	Text Codepad Items	39
4.22.1	Home Message	39
4.22.2	Zone Names	39
4.22.3	User Names	40
4.22.4	Area Names	40
<b>5</b>	<b>Appendices</b>	<b>41</b>
5.1	Connections for EOL Resistors	41
5.2	Wiring Diagram	42
5.3	Component Overlay	43

# 1 Introduction

Thank you for choosing the ICP-SOL2-P/ICP-SOL3-P Control Panel for your installation. You will find this system extremely flexible, reliable, and easy to use. This Quick Reference Guide is supplied with the system to provide users with enough basic information to wire, configure, and program the system. Due to the systems many programmable features and options, we suggest that you obtain the ICP-SOL2-P/ICP-SOL3-P Installation Guide that provides detailed information on system options, functions, and programming methods.

Throughout this document, the words “control panel ” refer to all control panels covered by this document (ICP-SOL2-P/ICP-SOL3-P).

Features	ICP-SOL2-P	ICP-SOL3-P
Number of users or RF keyfobs	32	32
Number of WE800EV2 keyfobs HCT-4	21	21
Number of RADION keyfobs RKF-TB or RKF-FB	0	32
Number of areas	2	2
Number of zones	4 (Onboard) + 4 (zone doubling)	8 (Onboard) + 8 (zone doubling)
Number of Onboard outputs	4	4
Number of text LCD codepads IUI-SOL-TEXT or ICON LCD codepads IUI-SOL-ICON	4	4
Number of wireless receiver WE800EV2	1	1
Number of RADION receiver B810	0	1
Number of RADION repeater RFRP	0	8
Number of B308 Octo-output Modules	1	1
Number of B426 Conettix Ethernet Communication Modules	2	2
Number of B450 Conettix Plug-in Communicator Interfaces	2	2

**Table 1.1: Control Panel Capacities**

## 2 Programming

The programming options of the system are stored in a non-volatile EPROM. This memory holds all information during a total power loss and can be changed as many times as required. The entire programming sequence consists of entering a location number and changing the data as required.

Use the following methods to program the system:

- Codepad
- A-Link Plus Software

### 2.1 ICON LCD Codepad Programming

The system must be disarmed (with no active alarm) to program the system. If there is an active alarm or the system is armed, enter the code for User 1 (Default = 2580) followed by the [#] key. (User Code 1 is factory default as the Master Code.)

1. Enter Installer's Programming Mode: Enter the installer code (Default = 1234) followed by the [#] key. Two beeps are heard and both the STAY and AWAY indicators flash simultaneously to indicate that you entered programming mode. The codepad indicators display the current data programmed in Location 0000 (first location of the Primary Telephone Number).
2. Programming: Move to the required location and program new data into location.
  - To move to another programming location, enter the location number followed by the [#] key. The data in the new location is displayed using the codepad indicators. (For example, if you enter [34 #], the system jumps to Location 0034, the beginning of the Subscriber ID Number For Receiver 1.)
  - To move to the next location, press the [#] key. This steps you to the next location. The data in the next location is displayed using the codepad indicators. (For example, if you are currently positioned at Location 0034, pressing [#] key takes you to Location 0035.)
  - To step back one location, press the [\*] key. (For example, if you are currently positioned at Location 0035, pressing the [\*] key returns to Location 0034.)
  - To change data in the current location, enter the new value (0 to 15) followed by the [\*] key. This stores the new data into the location. (For example, if you enter the value [14\*], the Zone 14 indicator display to represent the new data value.)
3. Exit from Installer's Programming Mode: Enter [960#]. Two beeps are heard and the STAY and AWAY indicators no longer display. The system returns to the disarmed state and is ready for use.

Task	Keystrokes
Enter Installer's Programming Mode	[1234#]
Exit from Installer's Programming Mode without saving changes	[958#]
Exit from Installer's Programming Mode with saving changes and panel reset	[960#]
Step to next Location	[#]
Step back one Location	[*]

Task	Keystrokes
Program new data into Location	[Data][*] (Data = 0 to 15)
Jump to another Location	[Location No.] [#]

Table 2.1: Quick Guide to Programming

Data Value	Zone Indicator														
	1	2	3	4	5	6	7	8	9	10	11	12	13	14	15
0															
1	X														
2		X													
3			X												
4				X											
5					X										
6						X									
7							X								
8								X							
9									X						
10										X					
11											X				
12												X			
13													X		
14														X	
15															X

Table 2.2: Codepad Indicators

## 2.2 TEXT LCD Codepad Menu Programming

1. Enable Text codepad and confirm that the system is in disarmed status.
2. To enter Installer's Programming Menu, enter the installer code (Default = 1234) followed by the [#] key or [-] key.
3. Programming: Select the menu and operate according to the menu prompt.
  - Down to the next menu: Press [▼]
  - Up to the previous menu: Press [▲]
  - Enter menu or confirm input : [#]
  - Back to the menu or exit programming item setting: Press [-]; or press and hold [-] for 3 seconds to exit programming without saving changes.
  - Operate according to the menu prompt. Select menu and enter or select data for specific programming items to complete programming, step by step. For specific items and options, refer to *Programming Parameters*, page 15.



4. After completing input, press [-] to get back to the previous menu. Complete all programming input by repeating step 3 and press [-] to get back to the current main menu level by level.
5. When [Confirm to Save Parameter Changes?] display, press [#] to save parameter changes , exit menu programming and reset system.

## 2.3 Programming Option Bits

Use option bits to program any combination of the four different options in one location by adding the options together. Programming a zero disables all four options.

### Example

If at Location 0177 you only want options 1, 2, and 4, add the numbers together and the total is the number to be programmed. The number to be programmed is 7 (1 + 2 + 4 = 7).

Option	Description
1	Dialer reporting functions allowed
2	Remote arming using Telephone allowed
4	Answering machine bypass only when armed
8	Use bell 103 for FSK format (Disabled = CCITT V21)

**Table 2.3: Programming Option Bits**

## 2.4 Installer's programming commands

Installer Programming Commands, displayed in below table can only be used when you enter Installer's Programming Mode. Enter the command followed by the [#] key.

Command	Description
958	Exit from Installer's Programming Mode without saving changes
959	Test IUI-SOL-ADAPTER
960	Exit from Installer's Programming Mode with saving changes and panel reset
961	Reset the control panel to factory defaults
962	Copy the control panel memory to IUI-SOL-ADAPTER
963	Copy IUI-SOL-ADAPTER data to the control panel memory
965	Set up domestic dialing format
966	Enable/disable the automatic stepping of locations during programming
999	Display the software version number or control panel type

**Table 2.4: Installer's Programming Commands**

### 3 Operating Commands

The system supports programmable 1- 4- digit Installer and User Code to execute the following operating commands.



#### Notice!

No identical User Codes are allowed. User Codes are not permitted to be the same as Installer codes.

Description	Command (Default User Code = 2580 Default Inst. Code = 1234)	Installer Code	User Code with Authority Levels
Arm in AWAY Mode	[Code] + [#]		√
	[Code] + [0] + [#] (arm all areas)		√
	Long press [#]		
Arm in STAY Mode 1	[Code] + [*]		√
	Long press [*]		
Arm in STAY Mode 2	Long press [0]		
Disarm in AWAY Mode	[Code] + [#] or [Code] + [*]		√
	[Code] + [0] + [#] (disarm all areas)		√
	Long press [#] (only if no alarm)		
Disarm in STAY Mode 1	[Code] + [#] or [Code] + [*]		√
	[Code] + [0] + [#] (disarm all areas)		√
	Long press [*] (only if no alarm)		
Disarm in STAY Mode 2	[Code] + [#] or [Code] + [*]		√
	[Code] + [0] + [#] (disarm all areas)		√
	Long press [0] (only if no alarm)		
Add/Delete RF Devices	[Code] + [0] + [#]	√	
Add/Delete RF Keyfob/ Repeater (ICON codepad only)	[Code] + [0] + [#]	√	
Set First Test Report	[Code] + [1] + [#]	√	
Add/Delete User Code/RF Keyfob	[Code] + [1] + [#]		√
Change Domestic Telephone Numbers	[Code] + [2] + [#]	√	√
Change Telco Arm/Disarm Sequence	[Code] + [3] + [#]	√	√
Set STAY Mode 2 Zones	[Code] + [4] + [#]	√	√
Turn Outputs On/Off	[Code] + [5] + [#]		√

Description	Command (Default User Code = 2580 Default Inst. Code = 1234)	Installer Code	User Code with Authority Levels
Report Monitor Mode	[Code] + [6] + [#]	√	
Setting Date and Time	[Code] + [6] + [#]		√
Walk Test Mode	[Code] + [7] + [#]	√	√
Event Memory Recall	[Code] + [8] + [#]	√	√
Duress Disarm	[Code] + [9] + [#] or [Code] + [3] + [#]		√
Zone Bypass (Zone Isolating)	[*] + [Code] + [*]		√
System Reset	[Code] + [9][9][8][9] + [#]		√
Enter User Menu (text codepad only)	[Code] + [-]		√
Enter Programming Menu	[Code] + [#] or [Code] + [-]	√	
Enter User Menu	[-]		
Exit Menu Without Saving changes	Long press [-]		
Codepad Panic Alarm	Press [1] and [3] or [*] and [#]		
Codepad Fire Alarm	Press [4] and [6]		
Codepad Medical Alarm	Press [7] and [9]		
Speaker Test	Long press [1]		
Bell Test	Long press [2]		
Strobe Test (Toggle On/Off)	Long press [3]		
Day Alarm (Toggle On/Off)	Long press [4]		
Fault Analysis	Long press [5]		
Modem Call (A-Link Plus)	Long press [6]		
Latching Output (Reset)	Long press [7]		
Display Codepad ID/Change Codepad Buzzer Tone	Long press [8]		
Test Report	Long press [9]		

**Table 3.1: Operating Commands**

**Notice!**

Below commands examples are operated via ICON LCD codepad IUI-SOL-ICON .

## 3.1 Add/Delete RF Device (Wireless Zones)

### Add RF Device

Set RF receiver as RADION Receiver.

1. Enter the Installer Code, followed by [0] and the [#] key (for example, [12340#]).
2. Enter the Device Number (1 to 16) you want to add, followed by the [#] key.
3. Use manual mode or auto-learn mode to configure device RFID.
  - In manual mode, enter the 9-digit RF device ID number, followed by the [#] key.
  - Or press [#] key to switch into auto-learn mode. When icon numbers (1 to 16) flash, generate the RF device. The panel learns the RF device ID number and the last digit of RFID number displays on the codepad. Press [#] key to confirm.
4. Enter RF zone option (0 to 15), followed by the [#] key. Or Enter [#] key directly.  
RF zone/device ID numbers and RF zone option, refer to *RF Zone/Device ID Numbers and RF Zone Option*, page 38.

### Delete RF Device

1. Enter the Installer Code, followed by [0] and the [#] key.
2. Enter the Device Number (1 to 16) you want to delete, followed by the [#] key.
3. Press the [\*] key to delete the RF device.

## 3.2 Add/Delete RF Repeater

### Add RF Repeater

Set RF receiver as RADION Receiver.

1. Enter the Installer Code, followed by [0] and the [#] key (for example, [12340#]).
2. Enter the point id of RADION Repeater (822 to 829) you want to add, followed by the [#] key. Repeater number (1 to 8 ) displays on the ICON codepad.
3. Use manual mode or auto-learn mode to configure Repeater RFID.
  - In manual mode, enter the 9-digit RF Repeater ID number, followed by the [#] key.
  - Or press [#] key to switch into auto-learn mode. When icon numbers (1 to 16) flash, generate the RF Repeater. The panel learns the RF Repeater ID number and the last digit of RFID number displays on the codepad. Press [#] key to confirm.
4. Enter [#] key to confirm the operation, or enter [\*] to cancel.

### Delete RF Repeater

1. Enter the Installer Code, followed by [0] and the [#] key.
2. Enter the point id of RADION Repeater (822 to 829) you want to delete, followed by the [#] key.
3. Press the [\*] key to delete the RF Repeater.

## 3.3 Add/Delete RF Keyfob

### Add WE800EV2 Keyfob

Set RF receiver as WE800EV2 Receiver.

1. Enter the Installer Code, followed by [0] and the [#] key (for example, [12340#]).
2. Enter the WE800EV2 keyfob number (301 to 321) you want to add, followed by the [#] key. Only current keyfob number (1 to 16 ) displays on the ICON codepad.

3. Only use auto-learn mode to configure keyfob RFID. Press [#] key to switch into auto-learn mode. When icon numbers (1 to 16) flash, press button 1 or 2 of the keyfob. The panel learns the WE800EV2 Keyfob ID number and the last digit of RFID number displays on the codepad. Press [#] key to confirm.
4. Enter [#] key to confirm the operation, or press [\*] to cancel.

#### **Delete WE800EV2 Keyfob**

1. Enter the Installer Code, followed by [0] and the [#] key.
2. Enter the WE800EV2 keyfob number (301 to 321) you want to delete, followed by the [#] key.
3. Press the [\*] key to delete the WE800EV2 Keyfob.

#### **Add RADION Keyfob**

Set RF receiver as RADION Receiver.

1. Enter the Installer Code, followed by [0] and the [#] key (for example, [12340#]).
2. Enter the RADION keyfob number (301 to 332) you want to add, followed by the [#] key. Only current keyfob number (1 to 16) displays on the ICON codepad.
3. Use manual mode or auto-learn mode to configure RADION keyfob RFID.
  - In manual mode, enter the 9-digit RF device ID number, followed by the [#] key.
  - Or press [#] key to switch into auto-learn mode. When icon numbers (1 to 16) flash, press button 1 or 2 of the keyfob. The panel learns the RADION Keyfob ID number and the last digit of RFID number displays on the codepad. Press [#] key to confirm.
4. Enter [#] key to confirm the operation, or press [\*] to cancel.

#### **Delete RADION Keyfob**

1. Enter the Installer Code, followed by [0] and the [#] key.
2. Enter the RADION keyfob number (301 to 332) you want to delete, followed by the [#] key.
3. Press the [\*] key to delete the RADION Keyfob.

### **3.4 Set First Test Report**

1. Enter the Installer Code, followed by [1] and the [#] key.
2. Enter the Number of Days (0 to 15) until the first test report is sent, followed by the [#] key.

### **3.5 Change Domestic Telephone Numbers**

Set up receiver transmission format as Domestic.

1. Enter the Installer Code or Master Code, followed by [2] and the [#] key.
2. Enter the telephone number, followed by the [#] key.
3. Enter the digits for the telephone number, followed by the [#] key.

If there is more than one telephone number, repeat *Step 2 to Step 4*.

### **3.6 Change the Telco Arm/Disarm Sequence**

#### **Telco Arm Sequence (Call Forward On)**

1. Enter the Installer Code or Master Code followed by [3] and the [#] key.
2. Press [1] followed by the [#] key.
3. Enter the **Call Forward On** sequence.
4. Press the [#] key to exit.

#### **Telco Disarm Sequence (Call Forward Off)**

1. Enter the Installer Code or Master Code followed by [3] and the [#] key.
2. Press [2] followed by the [#] key.
3. Enter the **Call Forward Off** sequence.
4. Press the [#] key to exit.

### 3.7 Set STAY Mode 2 Zones

1. Enter the Installer Code or Master Code, followed by [4] and the [#] key.
2. Enter the Zone Number you want the system to automatically isolate, followed by the [\*] key. Repeat if more than one zone must be automatically isolated when armed in STAY Mode 2.
3. Press the [#] key to exit.

### 3.8 Report Monitor Mode (Toggle On/Off)

1. Enter the Installer Code, followed by [6] and the [#] key.
2. Press and hold the [9] key until two beeps are heard to send a test report.

Zone Indicator	Dialing Event
1	Telephone Line Seized
2	Dialing Telephone Number / Network Connect
3	Handshake Received
4	Data Being Sent
5	Kiss-Off Received
None	Released Telephone Line / Idle

**Table 3.2: Report Monitor Mode**



#### Notice!

You must exit from Report Monitor Mode to resume normal operations.

### 3.9 Walk Test Mode

1. Enter the Installer Code or Master Code, followed by [7] and the [#] key.
2. Test each zone as required.
3. Press the [#] key to exit.

### 3.10 Event Memory Recall

Enter the Installer Code or Master Code, followed by [8] and the [#] key.

The last 256 events are displayed in reverse order (for example, most recent to least recent).

## 4 Programming Parameters

### 4.1 Phone Programming

#### 4.1.1 Receiver 1

Item	Location	Option	Default	New
Phone Number 1	0000 - 0015	0 = 0 and 10 15 = Telephone termination	15	
Phone Number 2	0016 - 0031	0 = 0 and 10 15 = Telephone termination	15	
Reserved	0032			
Transmission Format	0033	0 = Not used 1 = Contact ID 4 = Domestic 6 = SIA Fast 7 = SIA Slow 8 = CSVIP 9 = Email	1	
Subscriber ID Number	0034 - 0039		0	

#### 4.1.2 Receiver 2

Item	Location	Option	Default	New
Phone Number 1	0040 - 0055	0 = 0 and 10 15 = Telephone termination	15	
Phone Number 2	0056 - 0071	0 = 0 and 10 15 = Telephone termination	15	
Reserved	0072			
Transmission Format	0073	0 = Not used 1 = Contact ID 4 = Domestic 6 = SIA Fast 7 = SIA Slow 8 = CSVIP 9 = Email	1	
Subscriber ID Number	0074 - 0079		0	

### 4.1.3 Dialing Format

Item	Location	Option	Default	New
Dialing Format	0080	1 = Australian DTMF 2 = Reserved 3 = Reserved 4 = International DTMF 5 = Reserved 6 = Reserved	1	

### 4.1.4 External Network Module 1

Item	Location	Option	Default	New
External Network Module 1	0081	0 = Not used 1 = Use, do not configure 2 = Use and configure	0	

### 4.1.5 External Network Module 2

Item	Location	Option	Default	New
External Network Module 2	0082	0 = Not used 1 = Use, do not configure 2 = Use and configure	0	

### 4.1.6 Password for A-Link Plus/RSC Connection

Item	Location	Option	Default	New
Password for A-Link Plus/RSC Connection	0083 - 0092		0	

### 4.1.7 Telco Arming Sequence (Call Forward On)

Item	Location	Option	Default	New
Telco Arming Sequence	0113 - 0142	0 = 0 and 10 15 = Telephone termination	0	

### 4.1.8 Telco Disarm Sequence (Call Forward Off)

Item	Location	Option	Default	New
Telco Disarm Sequence	0143 - 0158	0 = 0 and 10 15 = Telephone termination	0	

### 4.1.9 Call Back Telephone Number

Item	Location	Option	Default	New
Call Back Telephone Number	0159 - 0174	0 = 0 and 10 15 = Telephone termination	0	



#### 4.1.10 Ring Count

Item	Location	Option	Default	New
Ring Count	0175	0 = Panel does not answer 1 - 13 = No. of rings until panel answers 14 = Answering machine bypass 2 15 = Answering machine bypass 1	8	

#### 4.1.11 Telephone Line Fail Options

Item	Location	Option	Default	New
Telephone Line Fail Options	0176	1 = Display FAULT Indicator when telephone line fails 2 = Sound alarm when system is armed 4 = Sound alarm when system is disarmed 8 = Reserved	0	



**Notice!**

Option 2 and 4 must be used in conjunction with Option 1 (for example, program 1,3,5, or 7).

#### 4.1.12 Dialer Options 1

Item	Location	Option	Default	New
Dialer Options 1	0177	1 = Dialer reporting functions allowed 2 = Remote arming by telephone allowed 4 = Answering machine bypass only when armed 8 = Use Bell 103 for FSK format (Disabled = CCITT V21)	9	

#### 4.1.13 Dialer Options 2

Item	Location	Option	Default	New
Dialer Options 2	0178	1 = Arm/Disarm Reports only if alarmed 2 = STAY Mode Arm/Disarm Reports Enable 4 = Delay siren until transmission complete 8 = Extend handshake wait time from 30 to 60 sec.	0	

### 4.1.14 Dialer Options 3

Item	Location	Option	Default	New
Dialer Options 3	0179	1 = Set DTMF dialing pluses to 1 digit/sec 2 = Lockout telephone line fail alarm 4 = Reserved 8 = Reserved	2	

### 4.1.15 A-Link Plus Options

Item	Location	Option	Default	New
A-Link Plus Options	0180	1 = Upload/download allowed 2 = Call back phone number required for upload/download 4 = Exit from upload/download connection on alarm 8 = Reserved	3	

## 4.2 Installer Code

Item	Location	Option	Default	New
Installer Code	0181		1	
	0182		2	
	0183		3	
	0184		4	

## 4.3 User Code Programming

Item	Location	Default	New	Authority Level Location	Default	New
User #01	0185	2		0189	10	
	0186	5				
	0187	8				
	0188	0				
User #02	0190 - 0193	15		0194	2	
User #03	0195 - 0198	15		0199	2	
User #04	0200 - 0203	15		0204	2	
User #05	0205 - 0208	15		0209	2	
User #06	0210 - 0213	15		0214	2	
User #07	0215 - 0218	15		0219	2	
User #08	0220	0		0224	3	

Item	Location	Default	New	Authority Level Location	Default	New
	0221 - 0223	15				
User #09	0225 - 0228	15		0229	2	
User #10	0230 - 0233	15		0234	2	
User #11	0235 - 0238	15		0239	2	
User #12	0240 - 0243	15		0244	2	
User #13	0245 - 0248	15		0249	2	
User #14	0250 - 0253	15		0254	2	
User #15	0255 - 0258	15		0259	2	
User #16	0260 - 0263	15		0264	2	
User #17	0566 - 0569	15		0570	2	
User #18	0571 - 0574	15		0575	2	
User #19	0576 - 0579	15		0580	2	
User #20	0581 - 0584	15		0585	2	
User #21	0586 - 0589	15		0590	2	
User #22	0591 - 0594	15		0595	2	
User #23	0596 - 0599	15		0600	2	
User #24	0601 - 0604	15		0605	2	
User #25	0606 - 0609	15		0610	2	
User #26	0611 - 0614	15		0615	2	
User #27	0616 - 0619	15		0620	2	
User #28	0621 - 0624	15		0625	2	
User #29	0626 - 0629	15		0630	2	
User #30	0631 - 0634	15		0635	2	
User #31	0636 - 0639	15		0640	2	
User #32	0641 - 0644	15		0645	2	

Authority Levels	Description
0	Arm/Disarm
1	Arm Only
2	Arm/Disarm and Arm/Disarm Reports
3	Arm Only and Arm Reports
4	Arm/Disarm and Code Required to Isolate

Authority Levels	Description
6	Arm/Disarm and Arm/Disarm Reports and Code Required to Isolate
8	Master Code and Arm/Disarm
10	Master Code and Arm/Disarm and Arm/Disarm Reports
12	Master Code and Arm/Disarm and Code Required to Isolate
14	Master Code and Arm/Disarm and Code Required to Isolate and Arm/Disarm Reports

Table 4.1: Authority Levels

## 4.4 Day Alarm Zones

Item	Location	Option	Default	New
Day Alarm Zones	0265	1 = Zone 1 2 = Zone 2 4 = Zone 3 8 = Zone 4	0	

## 4.5 EOL Resistor Value

Item	Location	Option	Default	New
EOL Resistor Value	0266	0 = No EOL 1 = 1k 2 = 1k5 3 = 2k2 4 = 3k3 5 = 3k9 6 = 4k7 7 = 5k6 8 = 6k8 9 = 10k 10 = 12k 11 = 22k 12 = Reserved 13 = Reserved 14 = Split EOL (3k3/6k8 with tamper 1k) 15 = Split EOL (3k3/6k8)	15	

## 4.6 Zone Programming

Item	Location	Default	New	Item	Location	Default	New
<b>Zone #01</b>				<b>Zone #09</b>			
Zone Type	0267	2		Zone Type	0323	15	
Zone Pulse Count	0268	0		Zone Pulse Count	0324	0	
Zone Pulse Count Time	0269	0		Zone Pulse Count Time	0325	0	
Zone Options 1	0270	1		Zone Options 1	0326	1	
Zone Options 2	0271	14		Zone Options 2	0327	14	
Reserved	0272			Reserved	0328		
Dialer Options	0273	1		Dialer Options	0329	1	
<b>Zone #02</b>				<b>Zone #10</b>			

Item	Location	Default	New	Item	Location	Default	New
Zone Type	0274	1		Zone Type	0330	15	
Zone Pulse Count	0275	0		Zone Pulse Count	0331	0	
Zone Pulse Count Time	0276	0		Zone Pulse Count Time	0332	0	
Zone Options 1	0277	1		Zone Options 1	0333	1	
Zone Options 2	0278	14		Zone Options 2	0334	14	
Reserved	0279			Reserved	0335		
Dialer Options	0280	1		Dialer Options	0336	1	
<b>Zone #03</b>				<b>Zone #11</b>			
Zone Type	0281	1		Zone Type	0337	15	
Zone Pulse Count	0282	0		Zone Pulse Count	0338	0	
Zone Pulse Count Time	0283	0		Zone Pulse Count Time	0339	0	
Zone Options 1	0284	1		Zone Options 1	0340	1	
Zone Options 2	0285	14		Zone Options 2	0341	14	
Reserved	0286			Reserved	0342		
Dialer Options	0287	1		Dialer Options	0343	1	
<b>Zone #04</b>				<b>Zone #12</b>			
Zone Type	0288	1		Zone Type	0344	15	
Zone Pulse Count	0289	0		Zone Pulse Count	0345	0	
Zone Pulse Count Time	0290	0		Zone Pulse Count Time	0346	0	
Zone Options 1	0291	1		Zone Options 1	0347	1	
Zone Options 2	0292	14		Zone Options 2	0348	14	
Reserved	0293			Reserved	0349		
Dialer Options	0294	1		Dialer Options	0350	1	
<b>Zone #05</b>				<b>Zone #13</b>			
Zone Type	0295	0		Zone Type	0351	15	
Zone Pulse Count	0296	0		Zone Pulse Count	0352	0	
Zone Pulse Count Time	0297	0		Zone Pulse Count Time	0353	0	
Zone Options 1	0298	1		Zone Options 1	0354	1	
Zone Options 2	0299	14		Zone Options 2	0355	14	
Reserved	0300			Reserved	0356		
Dialer Options	0301	1		Dialer Options	0357	1	
<b>Zone #06</b>				<b>Zone #14</b>			
Zone Type	0302	0		Zone Type	0358	15	

Item	Location	Default	New	Item	Location	Default	New
Zone Pulse Count	0303	0		Zone Pulse Count	0359	0	
Zone Pulse Count Time	0304	0		Zone Pulse Count Time	0360	0	
Zone Options 1	0305	1		Zone Options 1	0361	1	
Zone Options 2	0306	14		Zone Options 2	0362	14	
Reserved	0307			Reserved	0363		
Dialer Options	0308	1		Dialer Options	0364	1	
<b>Zone #07</b>				<b>Zone #15</b>			
Zone Type	0309	0		Zone Type	0365	15	
Zone Pulse Count	0310	0		Zone Pulse Count	0366	0	
Zone Pulse Count Time	0311	0		Zone Pulse Count Time	0367	0	
Zone Options 1	0312	1		Zone Options 1	0368	1	
Zone Options 2	0313	14		Zone Options 2	0369	14	
Reserved	0314			Reserved	0370		
Dialer Options	0315	1		Dialer Options	0371	1	
<b>Zone #08</b>				<b>Zone #16</b>			
Zone Type	0316	9		Zone Type	0372	15	
Zone Pulse Count	0317	0		Zone Pulse Count	0373	0	
Zone Pulse Count Time	0318	0		Zone Pulse Count Time	0374	0	
Zone Options 1	0319	1		Zone Options 1	0375	1	
Zone Options 2	0320	12		Zone Options 2	0376	14	
Reserved	0321			Reserved	0377		
Dialer Options	0322	1		Dialer Options	0378	1	

For zone item options, refer to below *Zone Item Options*.

Item	Option	
Zone Type	0 = Instant 1 = Handover 2 = Delay-1 3 = Delay-2 4 = Reserved 5 = Reserved 6 = 24-Hour Medical 7 = 24-Hour Panic	8 = 24-Hour Hold-up 9 = 24-Hour Tamper 10 = Reserved 11 = Keypad 12 = 24-Hour Burglary 13 = 24-Hour Fire 14 = Chime Only 15 = Not used
Zone Pulse Count	Use the pulse count to program how many pulses (0 to 15) need to be registered within the pulse count time to activate an alarm.	
Zone Pulse Count Time	<b>20 ms Loop Response Time</b>	<b>150 ms Loop Response Time</b>

Item	Option
	0 = 0.5 sec. 1 = 1 sec. 2 = 2 sec. 3 = 3 sec. 4 = 4 sec. 5 = 5 sec. 6 = 10 sec. 7 = 15 sec. 8 = 20 sec. 9 = 30 sec. 10 = 40 sec. 11 = 50 sec. 12 = 60 sec. 13 = 90 sec. 14 = 120 sec. 15 = 200 sec.
Zone Options 1	1 = Lockout siren/dialer 2 = Delay alarm report 4 = Silent alarm 8 = Sensor watch
Zone Options 2	1 = Isolated in STAY Mode 1 2 = Zone isolation allowed 4 = Forced arming allowed 8 = Zone Restore Report allowed
Zone Dialer Options	0 = No zone reports allowed 1 = Report to Receiver 1 2 = Report to Receiver 2 4 = Report to both Receiver 1 and Receiver 2 8 = Report to Receiver 2 only if Receiver 1 fails
Keyswitch Zone Options	0 = Latching arm and disarm in AWAY Mode 1 = Latching arm in AWAY Mode 2 = Latching disarm from AWAY Mode or STAY Mode 4 = Latching arm and disarm in STAY Mode 5 = Latching arm in STAY Mode 6 = Latching disarm from STAY Mode 8 = Momentary arm and disarm in AWAY Mode 9 = Momentary arm in AWAY Mode 10 = Momentary disarm from AWAY Mode or STAY Mode 12 = Momentary arm and disarm in STAY Mode 13 = Momentary arm in STAY Mode 14 = Momentary disarm from STAY Mode

Table 4.2: Zone Item Options

The keyswitch zone options replace Zone Options 1 only for the zones that were programmed to operate as a keyswitch zone.

## 4.7 Swinger Programming

### 4.7.1 Swinger Shutdown Count For Siren

Item	Location	Option	Default	New
Swinger Shutdown Count For Siren	0379	1 – 15 = Number of times siren operates until lockout	3	

### 4.7.2 Swinger Shutdown Count For Dialer

Item	Location	Option	Default	New
Swinger Shutdown Count For Dialer	0380	1 – 15 = Number of times dialer operates until lockout	6	

## 4.8 Zone Status Programming

### 4.8.1 STAY Mode 2 Automatically Bypass Zones

Item	Location	Option	Default	New
STAY Mode 2 Automatically Bypass Zones	0381	1 = Zone 1 2 = Zone 2 4 = Zone 3 8 = Zone 4	0	
	0382	1 = Zone 5 2 = Zone 6 4 = Zone 7 8 = Zone 8	0	
	0383	1 = Zone 9 2 = Zone 10 4 = Zone 11 8 = Zone 12	0	
	0384	1 = Zone 13 2 = Zone 14 4 = Zone 15 8 = Zone 16	0	

### 4.8.2 Reserved

Item	Location	Option	Default	New
Reserved	0385 - 0391			

### 4.8.3 Zone Status Reporting Options

Item	Location	Option	Default	New
Zone Status Reporting Options	0392	0 = No Zone status reports allowed 1 = Report to Receiver 1 2 = Report to Receiver 2 4 = Report to both Receiver 1 and Receiver 2 8 = Report to Receiver 2 only Receiver 1 fails	1	



## 4.9 RF Programming

### 4.9.1 RF Supervision Time

Item	Location	Option	Default	New
RF Supervision Time	0393	0 = Disable 2 = 2 hours 3 = 4 hours 4 = 12 hours 5 = 24 hours 6 = 48 hours 7 = 72 hours	0	

### 4.9.2 RADION Anti-Jamming Sensitivity

Item	Location	Option	Default	New
RADION Anti-Jamming Sensitivity	0394	0 = Disable 1 – 15 = Enable	12	

### 4.9.3 RF Receiver

Item	Location	Option	Default	New
RF Receiver	0395	0 = Not used 1 = Use RADION 2 = Use WE800EV2	0	

### 4.9.4 RF Options

Item	Location	Option	Default	New
RF Options	0396	1 = Siren Sound On RF Receiver Fail 2 = RF Receiver Jam/Tamper Siren Alarm 4 = Unseal Zone That Fail Monitor	0	

### 4.9.5 Reserved

Item	Location	Option	Default	New
Reserved	0397 - 0400			

## 4.10 Report Programming

### 4.10.1 Reserved

Item	Location	Option	Default	New
Reserved	0401 - 0402			

### 4.10.2 Arm / Disarm Reporting Options

Item	Location	Option	Default	New
Arm / Disarm Reporting Options	0403	0 = No Arm / Disarm Reports allowed 1 = Report to Receiver 1 2 = Report to Receiver 2 4 = Report to both Receiver 1 and Receiver 2 8 = Report to Receiver 2 only if Receiver 1 fails	1	

### 4.10.3 Reserved

Item	Location	Option	Default	New
Reserved	0404 - 0410			

### 4.10.4 Codepad Reporting Options

Item	Location	Option	Default	New
Codepad Reporting Options	0411	0 = No Codepad Alarm Reports allowed 1 = Report to Receiver 1 2 = Report to Receiver 2 4 = Report to both Receiver 1 and Receiver 2 8 = Report to Receiver 2 only if Receiver 1 fails	1	

## 4.11 System Status Programming

### 4.11.1 Reserved

Item	Location	Option	Default	New
Reserved	0412 - 0423			

### 4.11.2 Access Denied(Code Retry)

Item	Location	Option	Default	New
Code retry limit	0424	0 = Unlimited	6	
Reserved	0425 - 0426	1 - 15 = Error code attempts		

### 4.11.3 System Status Reporting Options

Item	Location	Option	Default	New
System Status Reporting Options	0427	0 = No report required 1 = Report to Receiver 1 2 = Report to Receiver 2 4 = Report to both Receiver 1 and Receiver 2 8 = Report to Receiver 2 only if Receiver 1 fails	1	

## 4.12 Test Report Programming

### 4.12.1 Test Report Time (Automatic)

Item	Location	Option	Default	New
Hour of day (tens digit)	0428		0	
Hour of day (units digit)	0429		0	
Minute of day (tens digit)	0430		0	
Minute of day (units digit)	0431		0	
Reserved	0432 - 0433			
Repeat interval in days	0434	0 = Disable 1 - 15 = 1 - 15 days	0	

### 4.12.2 Test Reporting Dialer Options

Item	Location	Option	Default	New
Test Reporting Dialer Options	0435	0 = No report required 1 = Report to Receiver 1 2 = Report to Receiver 2 4 = Report to both Receiver 1 and Receiver 2 8 = Report to Receiver 2 only if Receiver 1 fails	1	

## 4.13 Output Programming

Item	Location	Default	New	Item	Location	Default	New
<b>Output 1 (Default = Horn Speaker)</b>				<b>Relay Output (Default = Sirens Running)</b>			
Event Code	0436	1		Event Code	0454	1	
Event Code	0437	14		Event Code	0455	15	
Polarity	0438	0		Polarity	0456	1	
Time Base	0439	0		Time Base	0457	0	
Time Base Multiplier	0440	0		Time Base Multiplier	0458	0	
Time Base Multiplier	0441	0		Time Base Multiplier	0459	0	
<b>Output 2 (Default = Fire Alarm With Verification)</b>				<b>Codepad Buzzer (Default = Entry/Exit Warning and Day Alarm)</b>			
Event Code	0442	2		Event Code	0460	0	
Event Code	0443	7		Event Code	0461	13	
Polarity	0444	10		Polarity	0462	2	
Time Base	0445	2		Time Base	0463	1	
Time Base Multiplier	0446	1		Time Base Multiplier	0464	0	

Item	Location	Default	New	Item	Location	Default	New
Time Base Multiplier	0447	5		Time Base Multiplier	0465	1	
<b>Output 3 (Default = Strobe – Reset After 8 hrs.)</b>							
Event Code	0448	2					
Event Code	0449	0					
Polarity	0450	6					
Time Base	0451	4					
Time Base Multiplier	0542	0					
Time Base Multiplier	0453	8					
<b>B308 Output 1</b>				<b>B308 Output 2</b>			
Event Code	0646	0		Event Code	0652	0	
Event Code	0647	0		Event Code	0653	0	
Polarity	0648	0		Polarity	0654	0	
Time Base	0649	0		Time Base	0655	0	
Time Base Multiplier	0650	0		Time Base Multiplier	0656	0	
Time Base Multiplier	0651	0		Time Base Multiplier	0657	0	
<b>B308 Output 3</b>				<b>B308 Output 4</b>			
Event Code	0658	0		Event Code	0664	0	
Event Code	0659	0		Event Code	0665	0	
Polarity	0660	0		Polarity	0666	0	
Time Base	0661	0		Time Base	0667	0	
Time Base Multiplier	0662	0		Time Base Multiplier	0668	0	
Time Base Multiplier	0663	0		Time Base Multiplier	0669	0	
<b>B308 Output 5</b>				<b>B308 Output 6</b>			
Event Code	0670	0		Event Code	0676	0	
Event Code	0671	0		Event Code	0677	0	
Polarity	0672	0		Polarity	0678	0	
Time Base	0673	0		Time Base	0679	0	
Time Base Multiplier	0674	0		Time Base Multiplier	0680	0	
Time Base Multiplier	0675	0		Time Base Multiplier	0681	0	
<b>B308 Output 7</b>				<b>B308 Output 8</b>			
Event Code	0682	0		Event Code	0688	0	
Event Code	0683	0		Event Code	0689	0	
Polarity	0684	0		Polarity	0690	0	

Item	Location	Default	New	Item	Location	Default	New
Time Base	0685	0		Time Base	0691	0	
Time Base Multiplier	0686	0		Time Base Multiplier	0692	0	
Time Base Multiplier	0687	0		Time Base Multiplier	0693	0	

For output item options, refer to below *Output Item Options*.

Item	Option	
Event Code	0 0 = Reserved 0 1 = System armed 0 2 = System disarmed 0 3 = Armed in STAY mode 0 4 = Armed in AWAY mode 0 5 = Pre-arming alert 0 6 = Exit Warning (all zones sealed) and entry warning 0 7 = Exit Warning 0 8 = Exit Warning finished 0 9 = Kiss-off after end of Exit Time 0 10 = Reserved 0 11 = Entry warning 0 12 = Entry warning and day alarm resetting 0 13 = Exit warning and entry warning and day alarm resetting 0 14 = Day alarm resetting 0 15 = Day alarm latching	1 0 = Day alarm enabled 1 1 = Telephone line fail 1 2 = Kiss-off received 1 3 = Power Supply fail 1 4 = AC fail 1 5 = Low battery 1 6 = Output 1 to 3 fail 1 7 = Sensor watch alarm 1 8 = Codepad medical alarm 1 9 = Codepad fire alarm 1 10 = Codepad panic alarm 1 11 = Codepad duress alarm 1 12 = Access denied (code retries) 1 13 = Reserved 1 14 = Horn speaker (output 1 only) 1 15 = Siren running
Event Code	2 0 = Strobe 2 1 = Silent alarm 2 2 = Alarm in STAY mode 2 3 = Alarm in AWAY mode 2 4 = System fault 2 5 = Fire alarm (resetting) 2 6 = Fire alarm (latching) 2 7 = Fire alarm (verification) 2 8 = Remote control 1 2 9 = Remote control 2 2 10 = Remote control 3 2 11 = Radio control output 1 2 12 = Radio control output 2 2 13 = Radio control output 1- not in AWAY Mode 2 14 = Radio control output 2- not in AWAY Mode 2 15 = Communications fail after 3 attempts	3 0 = Communications fail 3 1 = Dialer disabled 3 2 = Dialer active (on-line) 3 3 = Ring detect 3 4 = Codepad/Keyfob panic 3 5 = Mimic zone 1 3 6 = Mimic zone 2 3 7 = Mimic zone 3 3 8 = Mimic zone 4 3 9 = Mimic zone 5 3 10 = Mimic zone 6 3 11 = Mimic zone 7 3 12 = Mimic zone 8 3 13 = Reserved 3 14 = Reserved 3 15 = Reserved

Item	Option	
Event Code	4 0 = Reserved 4 1 = Reserved 4 2 = Reserved 4 3 = Reserved 4 4 = Reserved 4 5 = Chime 4 6 = Zone not sealed 4 7 = Zone not sealed after Exit Time 4 8 = Reserved 4 9 = AC MAINS cycle (60 Hz or 50 Hz) 4 10 = Area 1 – zone unsealed 4 11 = Area 2 – zone unsealed 4 12 = Reserved 4 13 = Reserved 4 14 = Reserved 4 15 = Reserved	5 0 = Reserved 5 1 = Reserved 5 2 = Area 1 in alarm 5 3 = Area 2 in alarm 5 4 = Reserved 5 5 = Reserved 5 6 = Area 1 armed 5 7 = Area 2 armed 5 8 = Reserved 5 9 = Reserved 5 10 = Area 1 disarmed 5 11 = Area 2 disarmed 5 12 = Reserved 5 13 = Reserved 5 14 = Any areas armed 5 15 = Any areas disarmed
Event Code	6 0 = Reserved 6 1 = Reserved 6 2 = Remote control 4 6 3 = Remote control 5 6 4 = Remote control 6 6 5 = Remote control 7	6 6 = Remote control 8 6 7 = Remote control 9 6 8 = Remote control 10 6 9 = Remote control 11 6 10 = Remote control 12
Polarity (Modes)	0 = Output not used 1 = Normally open, going low 2 = Normally open, pulsing low 3 = Normally open, one shot low 4 = Normally open, one shot low (reactivate) 5 = Normally open, one shot low (can reset) 6 = Normally open, one shot low (alarm) 7 = Normally open, latching low	8 = Normally low, going open 9 = Normally low, pulsing open 10 = Normally low, one shot open 11 = Normally low, one shot open (reactivate) 12 = Normally low, one shot open (can reset) 13 = Normally low, one shot open (alarm) 14 = Normally low, latching open
Time Base	0 = Not Used 1 = 200 ms 2 = 1 sec.	3 = 1 min. 4 = 1 hr.
Time Base Multiplier	Enter a value between 00 and 99.	

Table 4.3: Output Item Options

**\* One Shot Mode**

When you program the output polarity as one shot, the time base is multiplied by the time base multiplier. (For example, if the time base = 2 and the multiplier = 05, the output operates for 5 sec.)

**\*Pulsing Mode**

When you program the output polarity as pulsing, the time base becomes the ON time and the multiplier becomes the OFF time. The OFF time is the time base x the multiplier. (For example, if you want the output to pulse 1 sec. ON and 5 sec. OFF, you would program time base as one and the multiplier as five.)

## 4.14 Time Programming

### 4.14.1 Entry Time 1

Item	Location	Option	Default	New
Increments of 1 sec. (0 to 15 sec.)	0466		4	
Increments of 1 6sec. (0 to 240 sec.)	0467		1	

### 4.14.2 Entry Time 2

Item	Location	Option	Default	New
Increments of 1 sec. (0 to 15 sec.)	0468		8	
Increments of 16 sec. (0 to 240 sec.)	0469		2	

### 4.14.3 Exit Time (AWAY/STAY Modes)

Item	Location	Option	Default	New
Increments of 1 sec. (0 to 15 sec.)	0470		12	
Increments of 16 sec. (0 to 240 sec.)	0471		3	

### 4.14.4 Entry Guard Time For STAY Mode

Item	Location	Option	Default	New
Increments of 1 sec. (0 to 15 sec.)	0472		0	
Increments of 1 6sec. (0 to 240 sec.)	0473		0	

### 4.14.5 Delay Alarm Report Time

Item	Location	Option	Default	New
Increments of 1 sec. (0 to 15 sec.)	0474		0	
Increments of 16 sec. (0 to 240 sec.)	0475		0	

### 4.14.6 Sensor Watch Time

Item	Location	Option	Default	New
Increments of days (tens digit)	0476		0	
Increments of days (units digit)	0477		0	

### 4.14.7 Codepad Lockout Time

Item	Location	Option	Default	New
Codepad Lockout Time	0478	0 = No lockout 1 – 15 = Lockout time 10 – 150 sec. (Increments of 10 sec.)	0	

**4.14.8 Siren Run Time**

Item	Location	Option	Default	New
Siren Run Time	0479	0 = No Siren time 1 – 15 = Siren time 1 – 15 min. (increments of 1 min.)	5	

**4.14.9 Siren Sound Rate**

Item	Location	Option	Default	New
Siren Sound Rate	0480	0 = Slowest frequency 15 = Fastest frequency	7	

**4.14.10 Auto Arming Pre-Alert Time**

Item	Location	Option	Default	New
Auto Arming Pre-Alert Time	0481	0 = No alert time 1 – 15 = Alert time 5 – 75 min. (increments of 5 min.)	1	

**4.14.11 Auto Arming Time**

Item	Location	Option	Default	New
Hour of the day (tens digit)	0482		0	
Hour of the day (units digit)	0483		0	
Minute of the day (tens digit)	0484		0	
Minute of the day (units digit)	0485		0	

**4.14.12 Auto Disarming Time**

Item	Location	Option	Default	New
Hour of the day (tens digit)	0486		0	
Hour of the day (units digit)	0487		0	
Minute of the day (tens digit)	0488		0	
Minute of the day (units digit)	0489		0	

**4.14.13 Kiss-Off Wait Time**

Item	Location	Option	Default	New
Increments of 500 ms (500 ms to 8 sec.)	0490		3	



#### 4.14.14 Speaker Beep Volume

Item	Location	Option	Default	New
Speaker Beep Volume	0491	0 = No Beeps 15 = Loudest Beeps	13	

### 4.15 Options Programming

#### 4.15.1 System Options 1

Item	Location	Option	Default	New
System Options 1	0492	1 = Bosch Security Systems smart lockout allowed 2 = Horn speaker monitor 4 = Strobe indication for radio arm/disarm 8 = Assign button 4 on transmitter to operate STAY Mode 1	1	

#### 4.15.2 System Options 2

Item	Location	Option	Default	New
System Options 2	0493	1 = Codepad panic to be silent 2 = Codepad fire to be silent 4 = Codepad medical to be silent 8 = Access denied (code retries) to be silent	0	

#### 4.15.3 System Options 3

Item	Location	Option	Default	New
System Options 3	0494	1 = AC fail after 1 hr. (Disabled = after 2 min.) 2 = Ignore AC fail 4 = Pulse count handover allowed 8 = Handover delay to be sequential	8	

#### 4.15.4 System Options 4

Item	Location	Option	Default	New
System Options 4	0495	1 = Panel to power up disarmed (if power reset) 2 = Arm/disarm tracking on power up 4 = Reserved 8 = Reserved	0	

**4.15.5 Consumer Options 1**

Item	Location	Option	Default	New
Consumer Options 1	0496	1 = Test reports only when armed 2 = Test report after siren reset 4 = Auto arm in STAY Mode 1 8 = STAY indicator to display day alarm status	0	

**4.15.6 Consumer Options 2**

Item	Location	Option	Default	New
Consumer Options 2	0497	1 = Codepad displays extinguish after 60 sec. 2 = Single button arming allowed (AWAY/STAY Modes 1 and 2) 4 = Single button disarming allowed (STAY Modes 1 and 2) 8 = Alarm memory reset on disarm	2	

**4.15.7 Consumer Options 3**

Item	Location	Option	Default	New
Consumer Options 3	0498	1 = Codepad fault beeps allowed 2 = Use digit 3 for codepad duress alarm (instead of digit 9) 4 = Alarms activate sirens and strobe outputs in STAY Modes 1 and 2 8 = Zone tamper alarms to be silent	5	

**4.15.8 Reserved**

Item	Location	Option	Default	New
Reserved	0499			

**4.15.9 Partitioning Options 1**

Item	Location	Option	Default	New
Partitioning Options 1	0500	1 = First to Disarm/Last to Arm reporting 2 = Reserved 4 = Reset sirens from any area allowed 8 = Reserved	0	

## 4.15.10 Partitioning Options 2

Item	Location	Option	Default	New
Partitioning Options 2	0501	1 = Reserved 2 = User codes allowed to arm/disarm both areas at same time (Code [0][#]) 4 = Reserved 8 = Reserved	0	

## 4.16 Partition Allocations

### 4.16.1 Zone Area Assignment

Item	Location	Default	New	Item	Location	Default	New
Zone partition 1	0502	1		Zone partition 9	0510	1	
Zone partition 2	0503	1		Zone partition 10	0511	1	
Zone partition 3	0504	1		Zone partition 11	0512	1	
Zone partition 4	0505	1		Zone partition 12	0513	1	
Zone partition 5	0506	1		Zone partition 13	0514	1	
Zone partition 6	0507	1		Zone partition 14	0515	1	
Zone partition 7	0508	1		Zone partition 15	0516	1	
Zone partition 8	0509	1		Zone partition 16	0517	1	
<b>Option</b>							
0 = Zone partition not assigned 1 = Zone partition assigned to Area 1				2 = Zone partition assigned to Area 2 3 = Zone partition assigned to both Area 1 and Area 2			

### 4.16.2 Codepad Assignment

Item	Location	Default	New	Item	Location	Default	New
Codepad address 1	0518	1		Codepad address 3	0520	0	
Codepad address 2	0519	0		Codepad address 4	0521	0	
<b>Option</b>							
0 = Codepad address not assigned 1 = Codepad address assigned to Area 1				2 = Codepad address assigned to Area 2 3 = Codepad address assigned to both Area 1 and Area 2			

### 4.16.3 Reserved

Item	Location	Option	Default	New
Reserved	0522 - 0533			

#### 4.16.4 User Code Area Assignment

Item	Location	Default	New	Item	Location	Default	New
User Code 1	0534	1		User Code 17	0550	1	
User Code 2	0535	1		User Code 18	0551	1	
User Code 3	0536	1		User Code 19	0552	1	
User Code 4	0537	1		User Code 20	0553	1	
User Code 5	0538	1		User Code 21	0554	1	
User Code 6	0539	1		User Code 22	0555	1	
User Code 7	0540	1		User Code 23	0556	1	
User Code 8	0541	1		User Code 24	0557	1	
User Code 9	0542	1		User Code 25	0558	1	
User Code 10	0543	1		User Code 26	0559	1	
User Code 11	0544	1		User Code 27	0560	1	
User Code 12	0545	1		User Code 28	0561	1	
User Code 13	0546	1		User Code 29	0562	1	
User Code 14	0547	1		User Code 30	0563	1	
User Code 15	0548	1		User Code 31	0564	1	
User Code 16	0549	1		User Code 32	0565	1	
<b>Option</b>							
0 = User code not assigned 1 = User code assigned to Area 1				2 = User code assigned to Area 2 3 = User code assigned to both Area 1 and Area 2			

#### 4.17 Default Options

Item	Location	Option	Default	New
Default Options	0900	0 = Button Factory Default Enable 15 = Button Factory Default Disabled	0	

#### 4.18 IP Destination

Item	Location	Option	Default	New
IP 1 + Port / Email	1000 - 1099			
CSVIP 1 User Name and Password	1100 - 1163			
IP 2 + Port / Email	1200 - 1299			
CSVIP 2 User Name and Password	1300 - 1363			

**Notice!**

Recommend to use A-Link Plus Software or text codepad IUI-SOL-TEXT to enter IP Destination items. Or enter IP Destination items via ASCII Character Codes with ICON codepad IUI-SOL-ICON .

**Program IP Destination with A-Link Plus Software or text codepad**

1. In receiver configuration, select Transmission Format as **CSVIP** , and enter **Subscriber ID Number**.
2. In network configuration, select Network Module as **Use, do not configure**.
3. Enter IP Destination (IP 1 + Port, or IP2 + Port), for example, **192.168.226.17:12000**.
4. Enter CSVIP User Name and Password:
  - Both user name and password, enter as user name with comma and password with comma, for example, **USER 1, 2580,**.
  - Only user name, enter as user name with two commas, for example, **USER 1,,**.
  - Only password, enter as comma, followed by password with comma, for example, **, 2580,**.
  - No user name and password, only enter two commas.
5. Download programming data from A-Link Plus to the control panel.

For A-Link Plus, enter 32 case sensitive alphanumeric characters for CSVIP User Name and Password directly through keyboard.

For text code, enter sensitive alphanumeric characters as below table.

Codepad Key	Characters / Function	Codepad key	Characters / Function
▲	Step back former character	6	[ m ], [ n ], [ o ], [ 6 ]
_	Exit item setting	7	[ p ], [ q ], [ r ], [ s ], [ 7 ]
▼	Move to next character	8	[ t ], [ u ], [ v ], [ 8 ]
1	[ . ], [ @ ], [ : ], [ _ ], [ 1 ]	9	[ w ], [ x ], [ y ], [ z ], [ 9 ]
2	[ a ], [ b ], [ c ], [ 2 ]	*	Case shift
3	[ d ], [ e ], [ f ], [ 3 ]	0	[ clear ], [ , ], [ / ], [ ? ], [ 0 ]
4	[ g ], [ h ], [ i ], [ 4 ]	#	Confirm item setting
5	[ j ], [ k ], [ l ], [ 5 ]		

**Table 4.4: Alphanumeric characters on text codepad**

**Program Email with A-Link Plus Software**

1. In receiver configuration, select Transmission Format as **Email**, and enter **Account** (Subscriber ID Number).
2. In network configuration, select Network Module **as Use and configure**.
3. Enter email receiver's email address.
4. Download programming data from A-Link Plus to the control panel.

## 4.19 RF User Code ID Numbers

Item	Location	Default	New	Item	Location	Default	New
RF User #01	1500 - 1507	0		RF User #17	1660 - 1667	0	
RF User #02	1510 - 1517	0		RF User #18	1670 - 1677	0	
RF User #03	1520 - 1527	0		RF User #19	1680 - 1687	0	
RF User #04	1530 - 1537	0		RF User #20	1690 - 1697	0	
RF User #05	1540 - 1547	0		RF User #21	1700 - 1707	0	
RF User #06	1550 - 1557	0		RF User #22	1710 - 1717	0	
RF User #07	1560 - 1567	0		RF User #23	1720 - 1727	0	
RF User #08	1570 - 1577	0		RF User #24	1730 - 1737	0	
RF User #09	1580 - 1587	0		RF User #25	1740 - 1747	0	
RF User #10	1590 - 1597	0		RF User #26	1750 - 1757	0	
RF User #11	1600 - 1607	0		RF User #27	1760 - 1767	0	
RF User #12	1610 - 1617	0		RF User #28	1770 - 1777	0	
RF User #13	1620 - 1627	0		RF User #29	1780 - 1787	0	
RF User #14	1630 - 1637	0		RF User #30	1790 - 1797	0	
RF User #15	1640 - 1647	0		RF User #31	1800 - 1807	0	
RF User #16	1650 - 1657	0		RF User #32	1810 - 1817	0	

## 4.20 RF Zone/Device ID Numbers and RF Zone Option

Item	Location	Default	New	RF Zone Option Location	Default	New
RF Zone #01	1820 - 1827	0		1828 - 1829	0	
RF Zone #02	1830 - 1837	0		1838 - 1839	0	
RF Zone #03	1840 - 1847	0		1848 - 1849	0	
RF Zone #04	1850 - 1857	0		1858 - 1859	0	
RF Zone #05	1860 - 1867	0		1868 - 1869	0	
RF Zone #06	1870 - 1877	0		1878 - 1879	0	
RF Zone #07	1880 - 1887	0		1888 - 1889	0	
RF Zone #08	1890 - 1897	0		1898 - 1899	0	
RF Zone #09	1900 - 1907	0		1908 - 1909	0	
RF Zone #10	1910 - 1917	0		1918 - 1919	0	
RF Zone #11	1920 - 1927	0		1928 - 1929	0	
RF Zone #12	1930 - 1937	0		1938 - 1939	0	

Item	Location	Default	New	RF Zone Option Location	Default	New
RF Zone #13	1940 - 1947	0		1948 - 1949	0	
RF Zone #14	1950 - 1957	0		1958 - 1959	0	
RF Zone #15	1960 - 1967	0		1968 - 1969	0	
RF Zone #16	1970 - 1977	0		1978 - 1979	0	

Item	Option		
RF Zone Option	0 = All Used 1 = Input 1 2 = Input 2 3 = Input 1 & 2 4 = Input 3 5 = Input 1 & 3	6 = Input 2 & 3 7 = Input 1 & 2 & 3 8 = Input 4 9 = Input 1 & 4 10 = Input 2 & 4	11 = Input 1 & 2 & 4 12 = Input 3 & 4 13 = Input 1 & 3 & 4 14 = Input 2 & 3 & 4 15 = Input 1 & 2 & 3 & 4

Table 4.5: RF Zone Options

## 4.21 RF Repeater ID Numbers

Item	Location	Default	New	Item	Location	Default	New
RF Repeater #01	1980 - 1987	0		RF Repeater #05	2020 - 2027	0	
RF Repeater #02	1990 - 1997	0		RF Repeater #06	2030 - 2037	0	
RF Repeater #03	2000 - 2007	0		RF Repeater #07	2040 - 2047	0	
RF Repeater #04	2010 - 2017	0		RF Repeater #08	2050 - 2057	0	

## 4.22 Text Codepad Items



### Notice!

Refer *IP Destination*, page 36 to enter sensitive alphanumeric characters with text codepad IUI-SOL-TEXT .

### 4.22.1 Home Message

Item	Location	Default	New
Home Message	2500 - 2535	Bosch Security Co.	

### 4.22.2 Zone Names

Item	Location	New	Item	Location	New
Zone 1 Name	2536 - 2559		Zone 9 Name	2728 - 2751	
Zone 2 Name	2560 - 2583		Zone 10 Name	2752 - 2775	
Zone 3 Name	2584 - 2607		Zone 11 Name	2776 - 2799	
Zone 4 Name	2608 - 2631		Zone 12 Name	2800 - 2823	

Item	Location	New	Item	Location	New
Zone 5 Name	2632 - 2655		Zone 13 Name	2824 - 2847	
Zone 6 Name	2656 - 2679		Zone 14 Name	2848 - 2871	
Zone 7 Name	2680 - 2703		Zone 15 Name	2872 - 2895	
Zone 8 Name	2704 - 2727		Zone 16 Name	2896 - 2919	

### 4.22.3 User Names

Item	Location	New	Item	Location	New
User 1 Name	2920 - 2943		User 17 Name	3304 - 3327	
User 2 Name	2944 - 2967		User 18 Name	3328 - 3351	
User 3 Name	2968 - 2991		User 19 Name	3352 - 3375	
User 4 Name	2992 - 3015		User 20 Name	3376 - 3399	
User 5 Name	3016 - 3039		User 21 Name	3400 - 3423	
User 6 Name	3040 - 3063		User 22 Name	3424 - 3447	
User 7 Name	3064 - 3087		User 23 Name	3448 - 3471	
User 8 Name	3088 - 3111		User 24 Name	3472 - 3495	
User 9 Name	3112 - 3135		User 25 Name	3496 - 3519	
User 10 Name	3136 - 3159		User 16 Name	3520 - 3543	
User 11 Name	3160 - 3183		User 27 Name	3544 - 3567	
User 12 Name	3184 - 3207		User 28 Name	3568 - 3591	
User 13 Name	3208 - 3231		User 29 Name	3592 - 3615	
User 14 Name	3232 - 3255		User 30 Name	3616 - 3639	
User 15 Name	3256 - 3279		User 31 Name	3640 - 3663	
User 16 Name	3280 - 3303		User 32 Name	3664 - 3687	

### 4.22.4 Area Names

Item	Location	New
Area 1 Name	3760 - 3783	
Area 2 Name	3784 - 3807	



# 5 Appendices

## 5.1 Connections for EOL Resistors

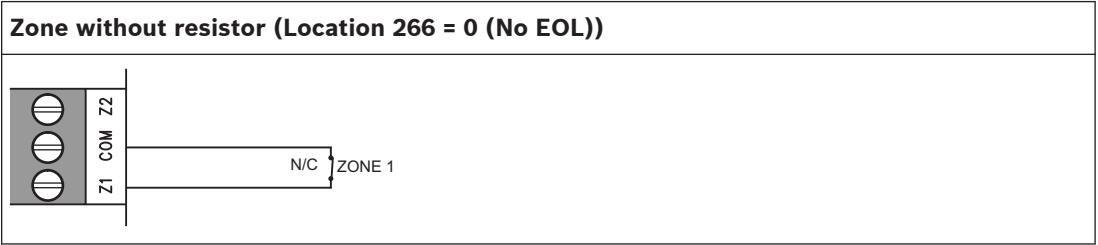

Table 5.1: Connection 1

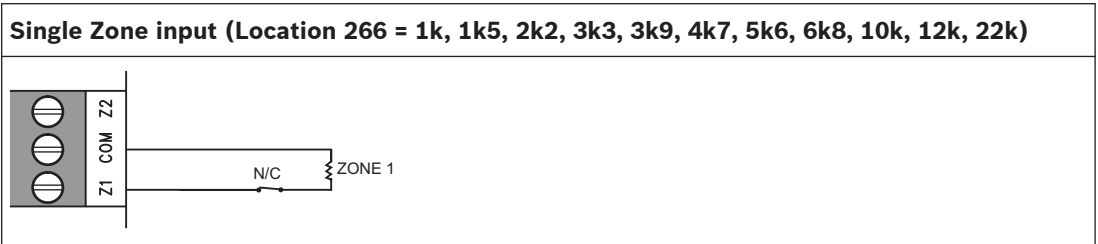

Table 5.2: Connection 2

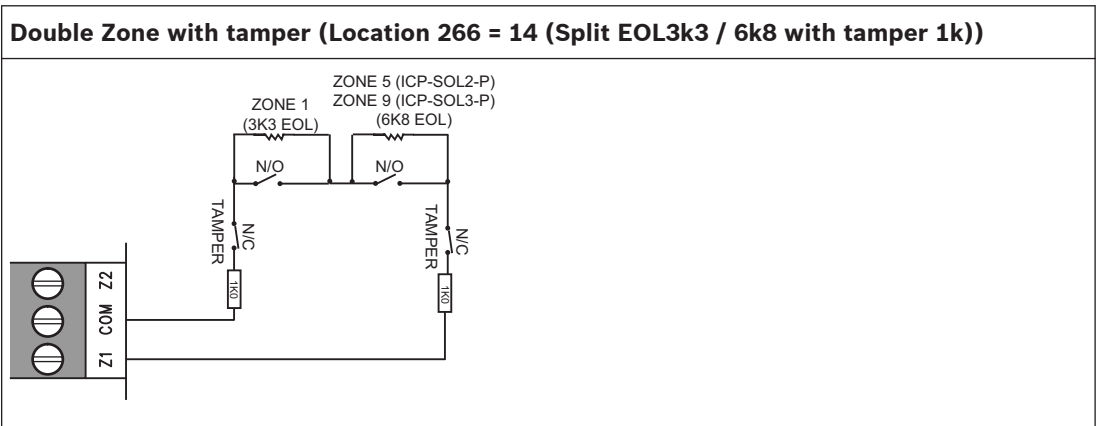

Table 5.3: Connection 3

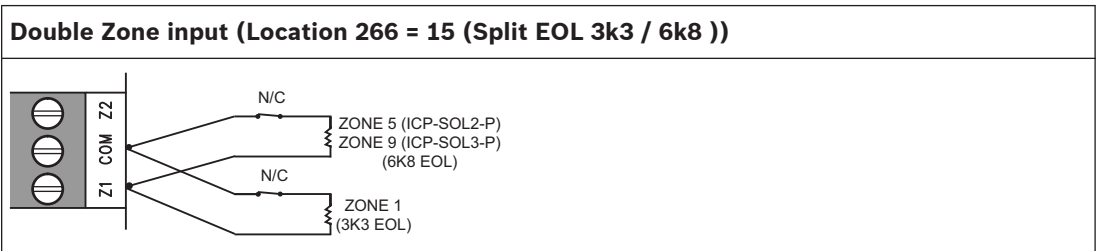

Table 5.4: Connection 4

## 5.2 Wiring Diagram

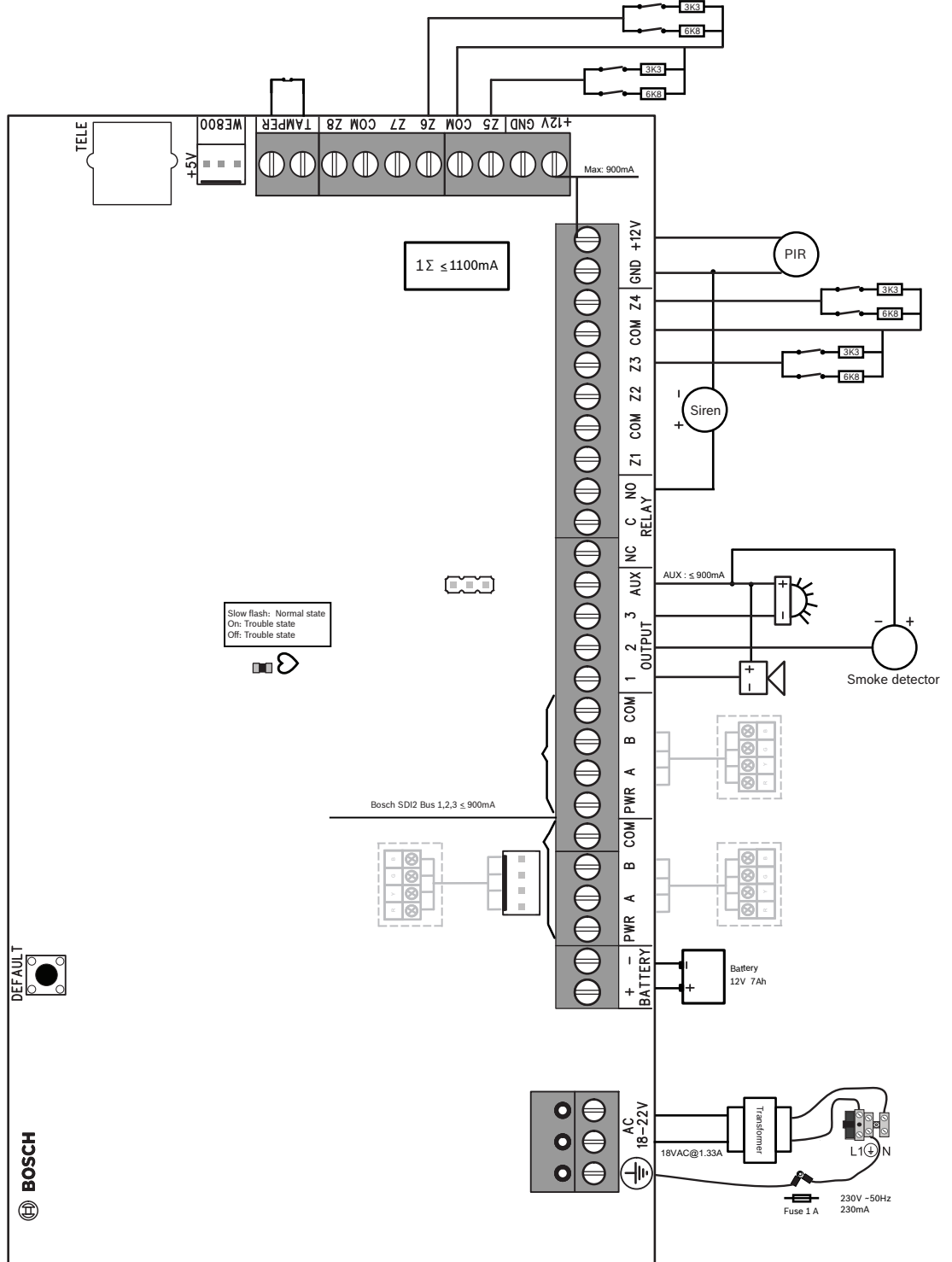

Figure 5.1: Wiring Diagram

### 5.3 Component Overlay

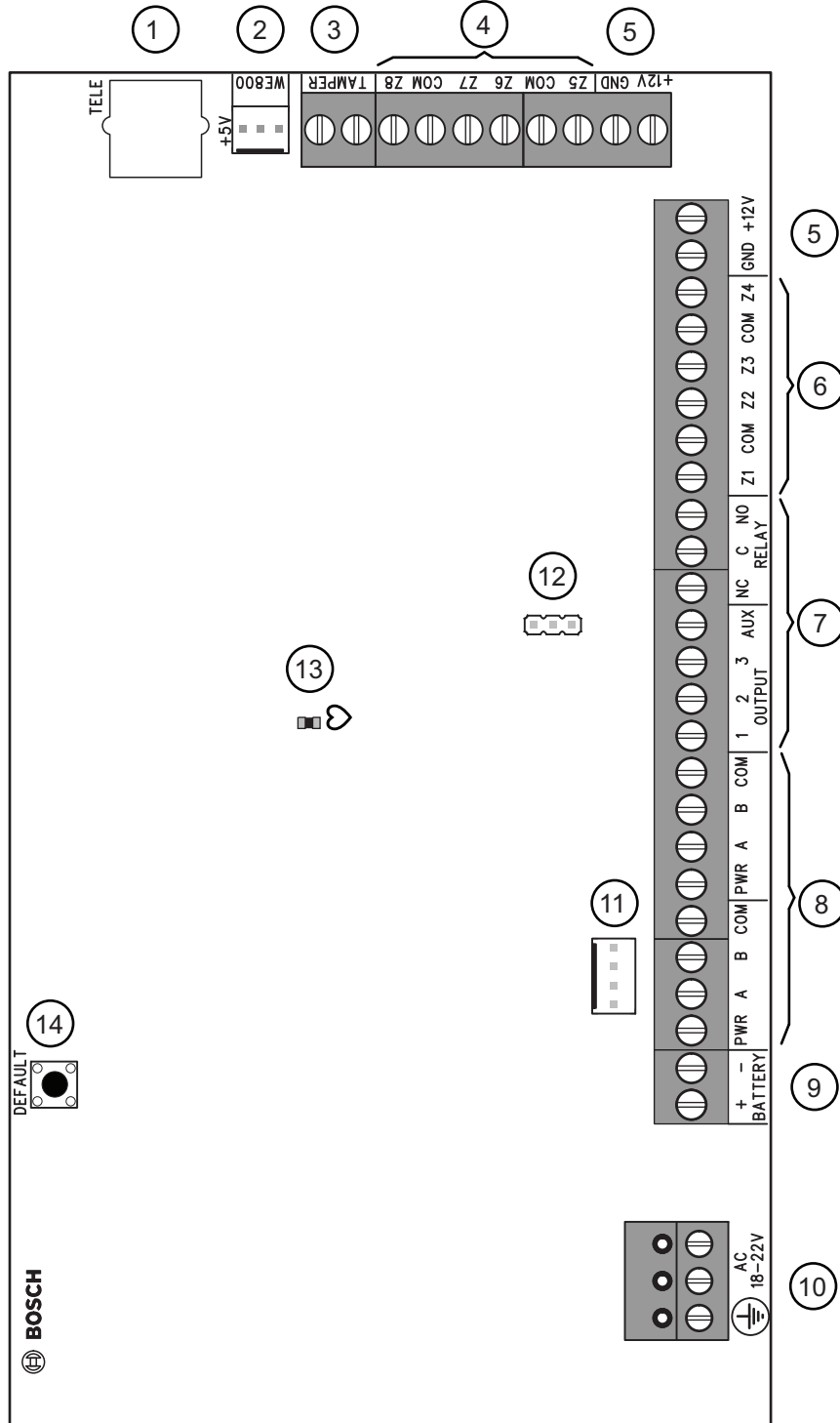
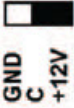

Figure 5.2: Component Overlay

Callout --Description	Callout --Description
1 – Socket for telecom lead connect	8 – Bosch SDI2 Bus
2 – Receiver interface connection	9 – Battery input
3 – Tamper switch	10 – Plug pack input (Bosch TF008)
4 – Zone 5-8 termination strip ( Zone 5 – 8 and Zone 13 – 16 for ICP-SOL3-P )	11 - Bosch SDI2 Bus
5 – AUX power	12 – Relay contact select   (select output GND or AUX as shown)
6 – Zone 1-4 termination strip ( Zone 1 - 4 and Zone 5 - 8 for ICP-SOL2-P; Zone 1 – 4 and Zone 9 – 12 for ICP-SOL3-P )	13 – LED indicator
7 – Output termination strip	14 – Default button

**Table 5.5: Callout description**



**Bosch Security Systems, Inc.**

130 Perinton Parkway

Fairport, NY 14450

USA

**[www.boschsecurity.com](http://www.boschsecurity.com)**

© Bosch Security Systems, Inc., 2014