



Four-wire

Villa Intercom System

Installer & User Manual



Please read this user manual carefully before using the products. Please keep it for future reference.

Content

- 1. Components 1
- 2. Door Station Installation 1
- 3. Indoor Phone Installation 3
- 4. Door Station Switch Installation 3
- 5. System Diagrams 4
 - One door station 4
 - Two door stations 5
 - Signal unlock 6
 - Power unlock 6
 - Indoor phone Jumper Setting 6
- 6. Specifications 6
- 7. Product Appearance 7
- 8. Operation 8

Any question towards our product distributors or, please contact Genway agents .Genway customer service center directly

— sale service consultation procedure-After —

- Describe product name.
- Describe product model.
- Describe the trouble.
- mail address-and e. Leave your Tel No.

———— Statement ————

Please forgive us if we could not notify you timely .towards any alteration to our product model No .or technical parameter s manual is not consistent with the actual'If the user the, operations due to technology upgrading .explanation right is reserved to Genway company

8. Operation

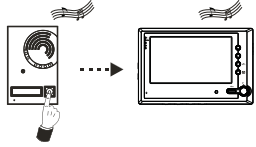

Call

1. When a visitor presses the call button of door station, the indoor phone rings, and the screen shows the visitor's image.
2. If there is no answer, the system will automatically reset to standby state after 60s.

[Note] If the system have two door stations, it will ring busy tone when calling from the other door station as the line is busy.

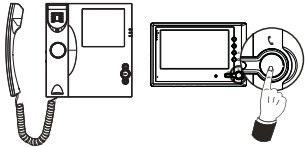

Talk

1. Pick up the handset of indoor phone to talk with the visitor. (If hands-free indoor phone: press button)
2. During talk, hang up the handset to end the talk. (If hands-free indoor phone: press button)

[Note] It will automatically end the talk after 120s.

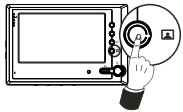

Monitor

1. In standby state, press button of indoor phone to monitor the conditions around the door station.
2. If there are two door stations, the monitor for different entrances is available by turns.

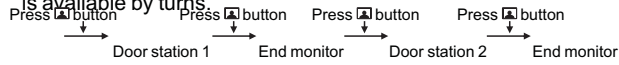

3. In monitor state, pick up the handset of indoor phone can talk to the visitor. (If hands-free indoor phone: press button)

[Note] It will automatically end the monitor after 60s;
If someone calls from door station, it will end monitoring and begin to call immediately.

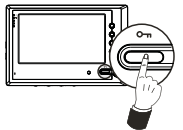

Unlock

In ring, talk or monitor state, press button of indoor phone to open the door, at the same time, the door phone and the indoor phone will sound "di" to prompt that door is open.

Mute setting between indoor phone

Adjust the (Ring Volume Adjustment) of indoor phone to the lowest, the ring will turn off, and the indicator is on.

1. In standby state, press button in any of the indoor phones (1st indoor phone), the other indoor phones will ring together.
2. Pick up the handset (if hands-free indoor phone: press button) of one indoor phone (2nd indoor phone), the other indoor phones will stop ringing ;

3. At this time pick up the handset (if hands-free indoor phone: press button) of the 1st indoor phone, intercom is available between the 1st and the 2nd indoor phones.

[Note] 1. You can also pick up the handset of the indoor phone, then press button to start the intercom.

2. There is no image during the intercom between indoor phone.

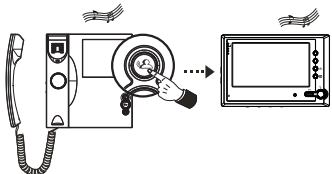
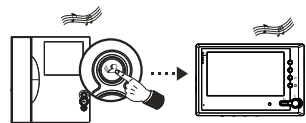

1. Components

Option of door station

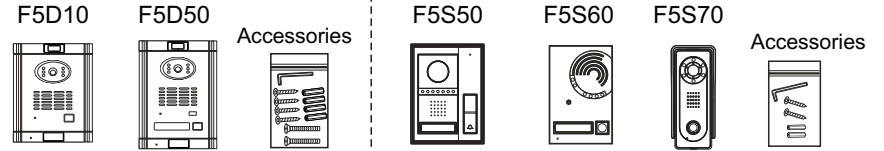

Option of indoor phone

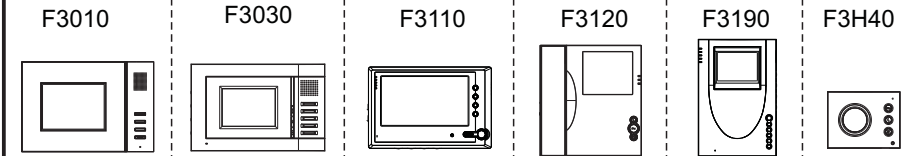

Other fittings

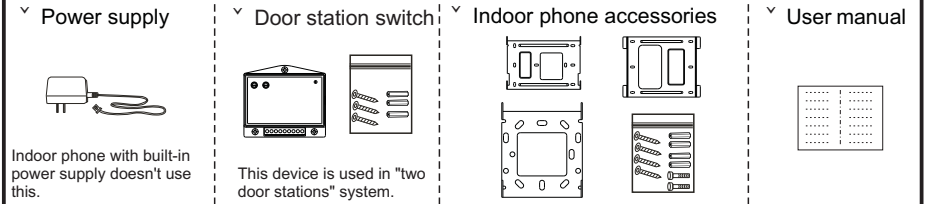

[Note] The power supply varies in different countries, please check with us before ordering.

2. Door Station Installation

F5S50

Unit: mm

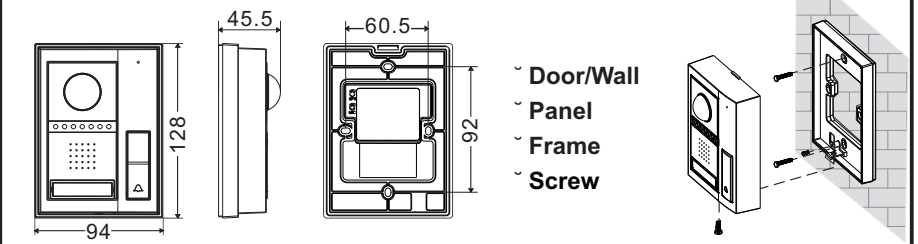

F5S60

Unit: mm

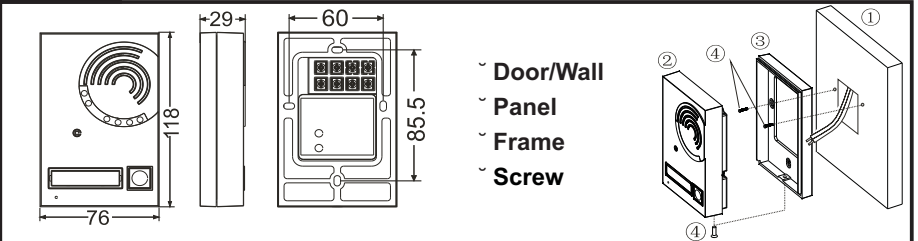

Change name plate

1. Insert the screw driver in the notch. Turn and push the plastic upwards.

2. Change the name plate.

3. Put the plastic back to the groove.

Name plate

Plastic

F5D10/F5D50

Built-in Installation

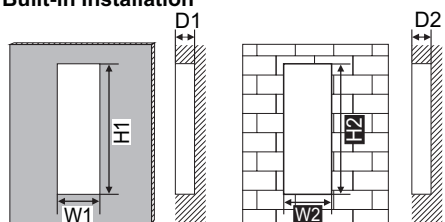

	Iron door Installation size (H1)*(W1)*(D1)	Wall Installation size (H2)*(W2)*(D2)
F5D10	166*108*38	164*126*42
F5D50	208*108*38	206*126*42

Unit: mm

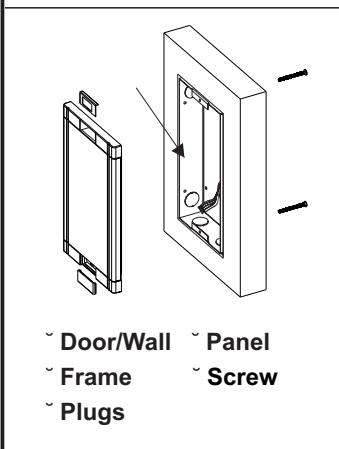

Change name plate

1. Push the right edge and move to right.

2. Take off the plastic.

3. Change the name plate.

4. Then insert the right edge into sideling.

5. Push the left edge and move to left.

201

Name plate

Plastic

F5S70

Unit: mm

58

48

135

60

During installation, put the wire through the hole of PC plate, then connect it with door station terminal, and glue the PC plate on the door station rear panel at last.

Door/Wall

Panel

Frame

Screw

PC plate

7. Product Appearance

Door station

1 Camera

2 MIC

3 Speaker

4 Call button

5 Name plate

6 Sensitive LED

Indoor phone

~ Status indicator

- Power Supply indicator
- Busy indicator
- Mute indicator

~ Buttons

- Talk button
- Monitor button
- Unlock button
- Internal call button

~ Adjustment

- Brightness Adjustment
- Contrast Adjustment
- Chroma Adjustment
- Ring Volume Adjustment
- Talk Volume Adjustment

Signal unlock (Note: this way of unlocking needs separate power supply.)

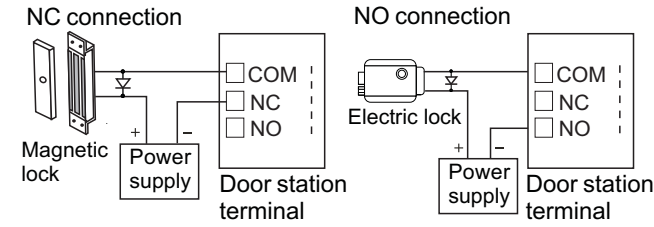

Power unlock

(Note: only F5D10, F5D50, and F5S50 have this function)

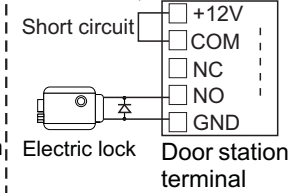

Indoor phone Jumper Setting

There are several jumpers on indoor phone rear panel, adjust them as follows:

1. Main indoor phone setting

If have one indoor phone, adjust the jumper as follows:



If have more then one indoor phone, set one of indoor phone as the main indoor phone, and set the others as subsidiary indoor phone, adjust the jumper as follows:

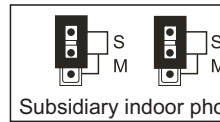
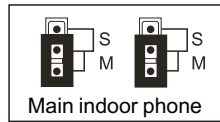

2. Unlock time setting

The unlock time on the indoor phone can be set separately. Adjust the jumper as follows:

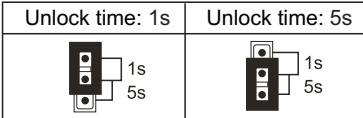

3. Video matching

The last indoor phone's Video matching jumper should be "ON". The "System Diagrams" has the details.

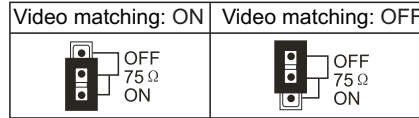

[Note] Please disconnect the power when setting the jumpers, after completing, restart the indoor phone.

6. Specifications

Door station model	F5D10 F5D50 F5S50 F5S60 F5S70	F 5 D1 0 - C color camera (or it is B&W) Function: Call/Talk/Access control Shell No. Villa door station code Four-wire system	Indoor phone model	F3010 / F3030 / F3110 / F3120 / F3190/ F3H40 F 3 03 0 - X B: Black & White (or it is color) N: Built-in power supply Number: Lcd screen size Function: Call/Talk/Access control Shell No. Indoor phone code Four-wire system
Technical parameter	Operating voltage: DC 14V Operating current: 200mA(DC 14V) Quiescent current: 30mA(DC 14V) Temperature: -40~+70° Humidity: 10%~95%		Technical parameter	Operating voltage: DC 14V Operating current: 700mA(DC 14V) Quiescent current: 100mA(DC 14V) Temperature: -10~+55° Humidity: 10%~95% Screen size: 4" CRT/ 5" TFT/ 7" TFT Resolution: 450 Line/320*324/480*324
Camera	Black & White 1/3 CCD&CMOS PAL system Visible angle: 90° Light source: infrared Min. Illumination: 0.1 Lux	Color 1/3 CCD&CMOS PAL system Visible angle: 90° Light source: white light LED Min. Illumination: 0.1 Lux		

△ Installation tips

- Don't install door station near humid, stove, and dusty condition.
- Mind the installation size while producing a groove for the back cover.
- Control the depth of the groove carefully so that it is the same as the one of the back cover.
- There are waterproof silicon sheet attached on the door station's back side, please install the door station to the smooth wall to guarantee the waterproof function.
- We suggest the installation height between 1100mm and 1400mm. But please also consider other situations such as view angle of the camera and disabled persons.

3. Indoor Phone Installation

Bracket	Size:	Unit: mm
		220X203X63, 237X158X44, 110X86X20
Method 1	Method 2	Method 1, Method 2

4. Door Station Switch Installation

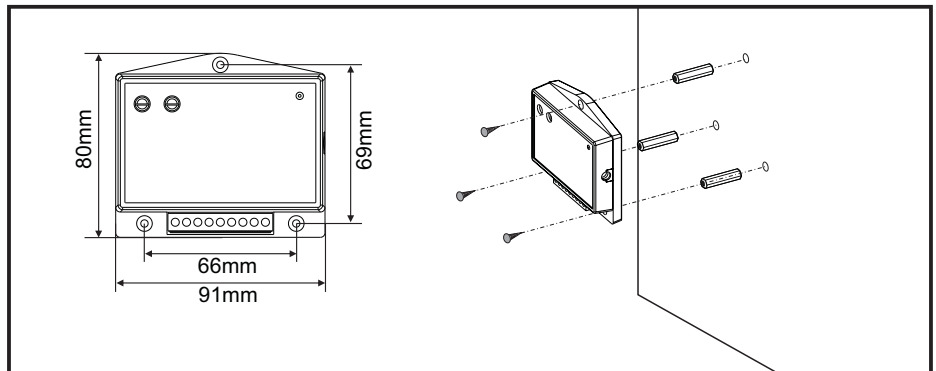

5. System Diagrams (one door station)

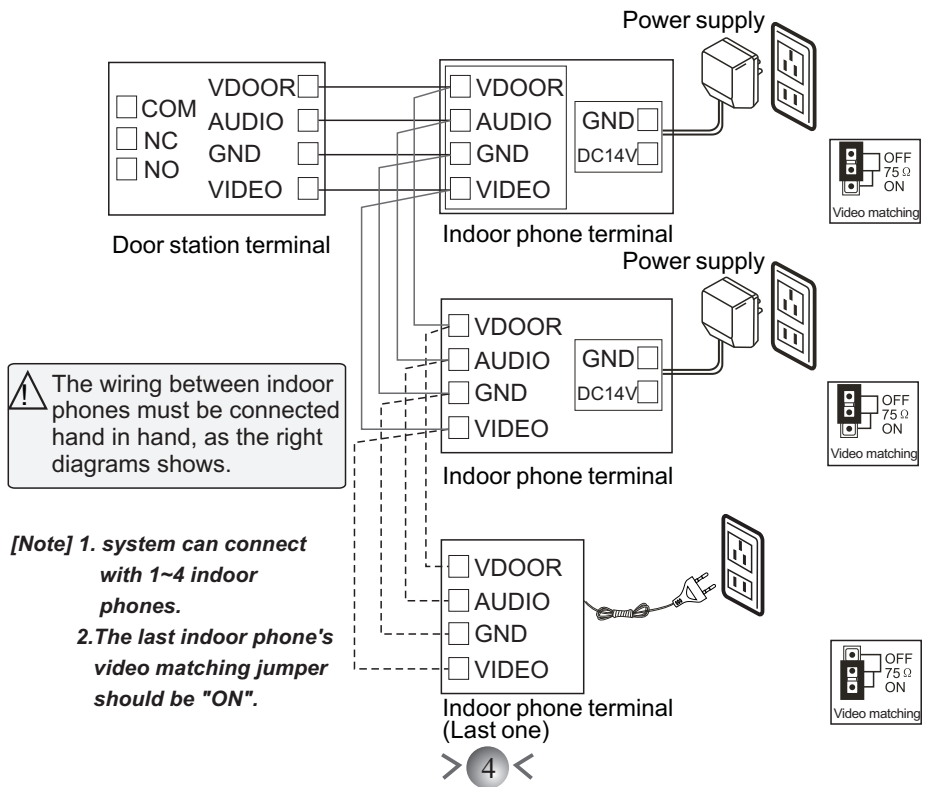
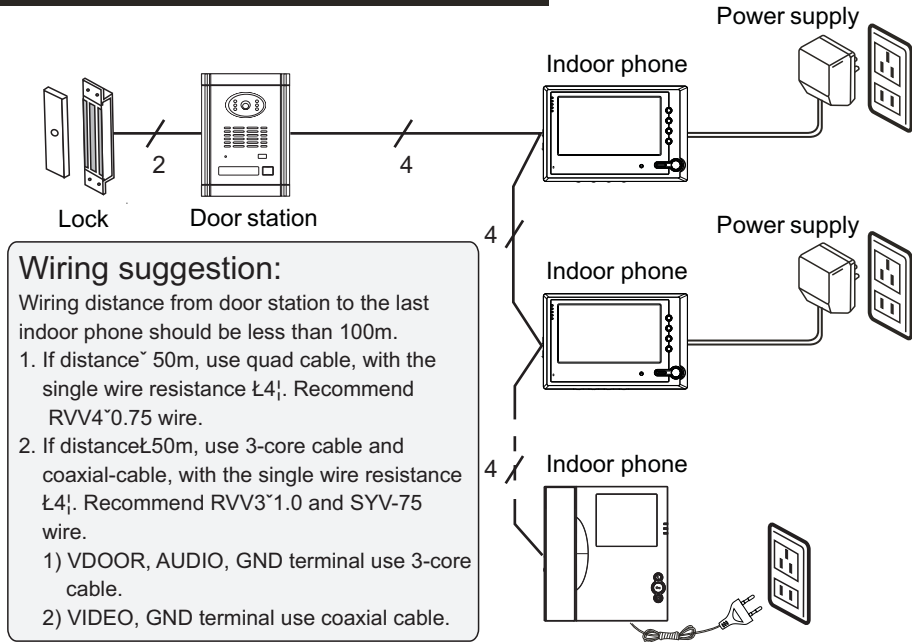

5. System Diagrams (two door stations)

